



# TYPHOON INTAKE SYSTEMS

INTAKE SYSTEMS FOR VEHICLES LISTED ARE 50 STATE LEGAL. SEE KNFILTERS.COM FOR CARB STATUS ON EACH PART FOR A SPECIFIC VEHICLE.

## INSTALLATION INSTRUCTIONS

**69-3511TP**  
**69-3511TR**  
**FORD**  
**2002-04 Focus SVT**  
**L4-2.0L DOHC**

**TOOLS NEEDED:**

- Flat Blade Screwdriver
- Ratchet
- 10mm socket
- 13mm end wrench
- 2.5mm Allen wrench

**PARTS LIST:**

Description	Qty.	Part #
A HOSE CLAMP #44, SS	3	08560
B HOSE; 2-3/4"ID X 2", BLACK	1	08440
C WASHER; 8MM, FLAT, SS	1	08272
D HOSE; 1/2"ID X 7"L, BLACK	1	08159
E BOLT; M4-0.7X 16MM, CHA, SS	2	07793
F TYPHOON TUBE	1	27139
G NUT; 6MM NYLOCK, SS	4	07512
H WASHER; 6MM WAVE, SS	4	08277
I STUD; RUBBER MOUNT 6MM	2	07027
J AIR FILTER	1	RU-4960
K HEAT SHIELD; 69-3511	1	07304
L NUT; 8MM NYLOCK, SS	1	07503
M WRENCH; TORX T-20 L-KEY	1	69801

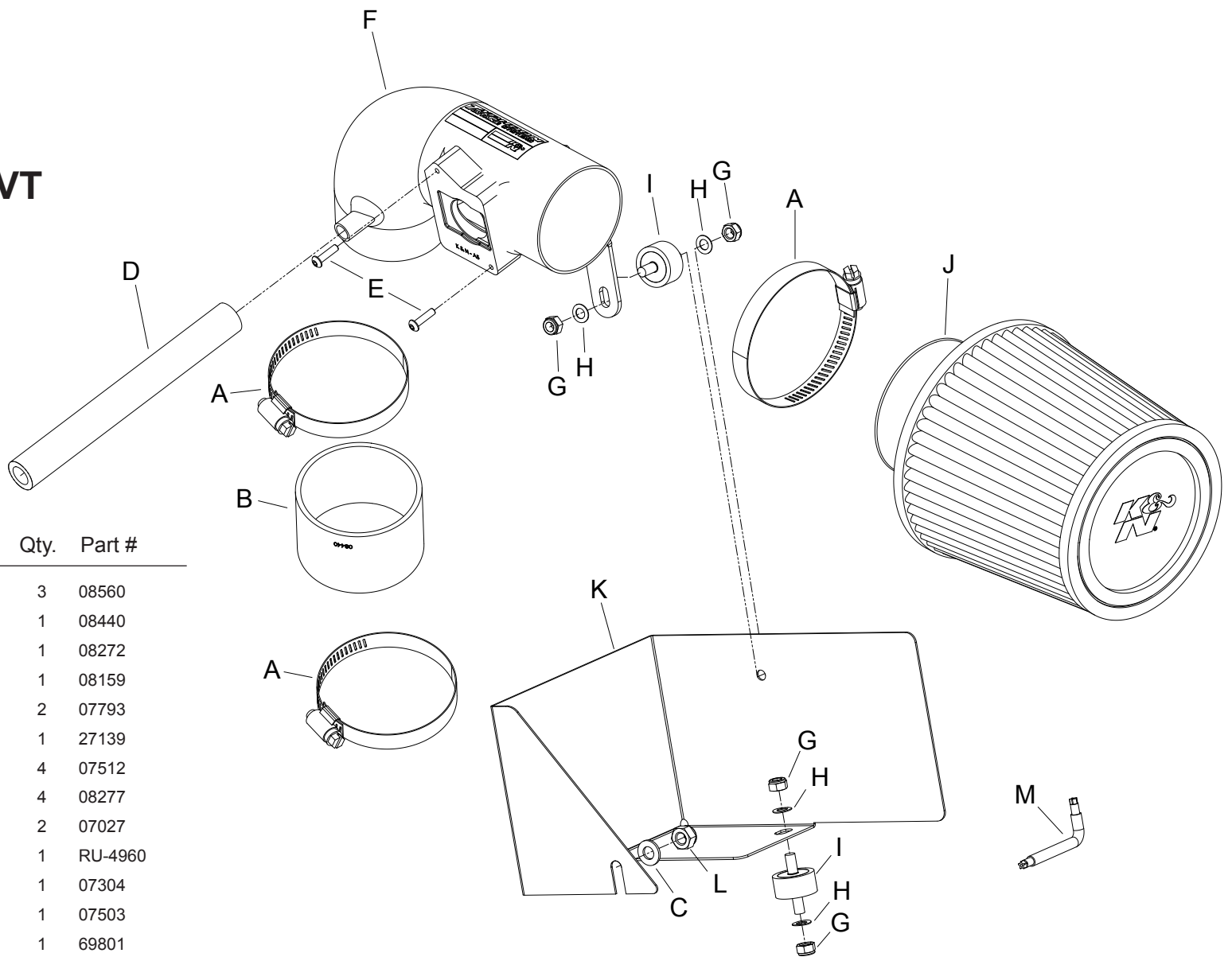

**NOTE: FAILURE TO FOLLOW INSTALLATION INSTRUCTIONS AND NOT USING THE PROVIDED HARDWARE MAY DAMAGE THE INTAKE TUBE, THROTTLE BODY AND ENGINE.**

**TO START:**

1. Turn off the ignition and disconnect the negative battery cable.  
**NOTE: Disconnecting the negative battery cable erases pre-programmed electronic memories. Write down all memory settings before disconnecting the negative battery cable. Some radios will require an anti-theft code to be entered after the battery is reconnected. The anti-theft code is typically supplied with your owner's manual. In the event your vehicles anti-theft code cannot be recovered, contact an authorized dealership to obtain your vehicles anti-theft code.**



2. Disconnect the mass air sensor electrical connection as shown.



3. Pull up firmly to remove the plastic throttle linkage cover as shown.



4. Pull up firmly to remove the plastic coil cover as shown.

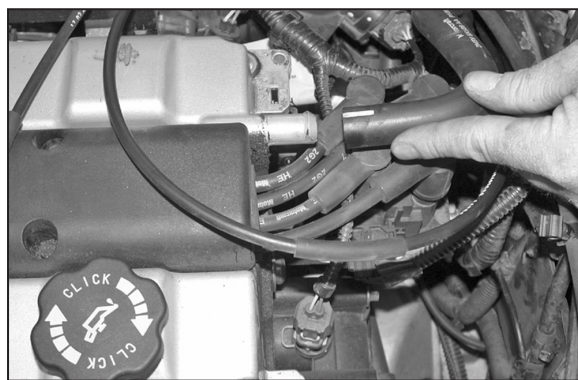

5. Disconnect the crank case vent hose from the cam cover as shown.



6. Remove the clamp at the throttle body as shown.



7. Pull firmly upwards to remove the air cleaner assembly as shown.  
**NOTE: K&N Engineering, Inc., recommends that customers do not discard factory air intake.**

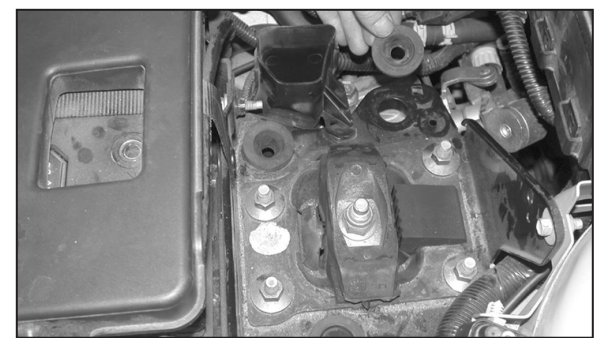

8. Remove the rubber bumper from the air cleaner tray as shown.

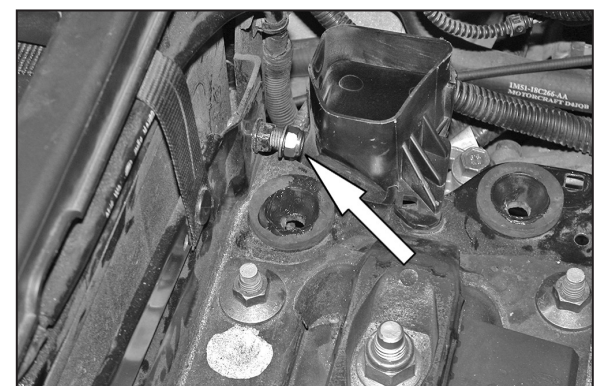

9. Install the provided nut and washer onto the stock bolt on the air cleaner tray as shown.

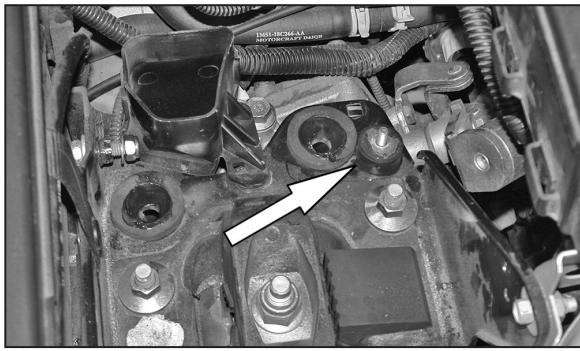

10. Install the rubber mounted stud onto the battery tray and secure with the provided hardware as shown.

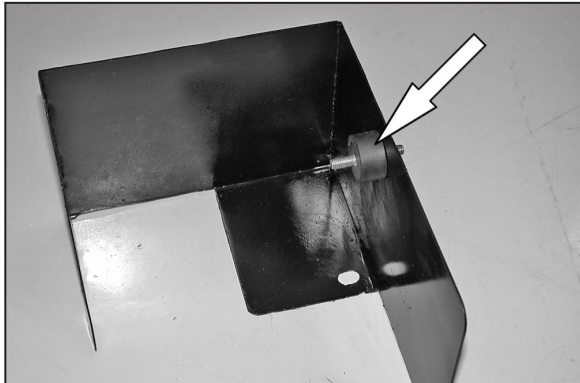

11. Install the rubber mounted stud onto the heat shield and secure it with the provided hardware as shown.

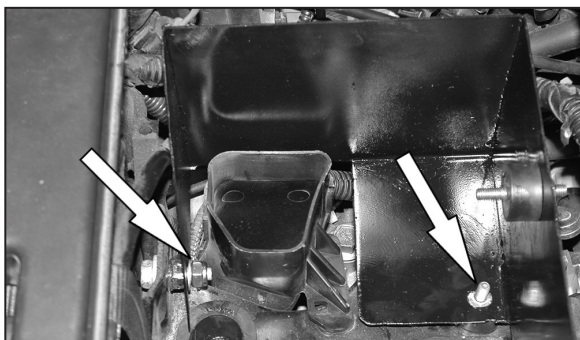

12. Install the heat shield into the vehicle and slide the slot on the heat shield onto the bolt from step 9, then, line up the hole with the rubber mounted stud from step 10 as shown.



13. Secure the heat shield to the rubber mounted stud using the provided hardware as shown.



14. Tighten the hex nut on the heat shield as shown.



15. Remove the mass air sensor from the stock air cleaner assembly as shown using the provided Torx wrench.

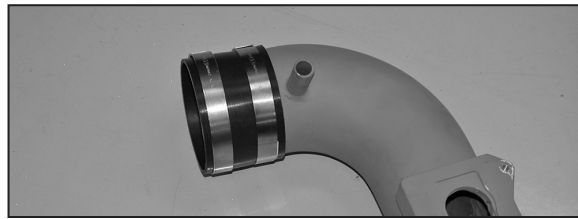

16. Install the silicone hose and hose clamps onto the K&N Typhoon intake tube as shown.

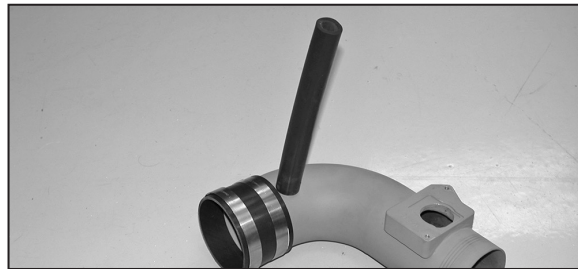

17. Install the provided silicone hose onto the vent on the K&N Typhoon intake tube as shown.

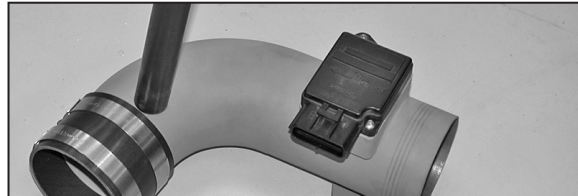

18. Install the mass air sensor into the tube and secure with the provided hardware as shown.

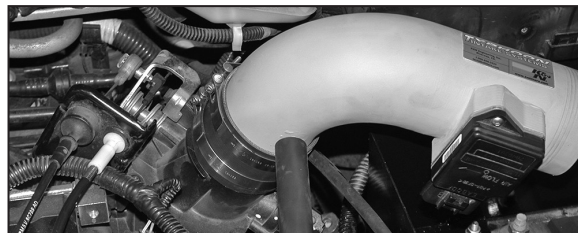

19. Install the tube into the vehicle and onto the throttle body as shown.



20. Line up the tube bracket with the rubber mounted stud and secure with the provided hardware as shown.



21. Install the air filter onto the Typhoon intake tube and tighten as shown.

**NOTE: Drycharger air filter wrap; part #RX-4990DK is available to purchase separately. To learn more about Drycharger filter wraps or look up color availability please visit <http://www.knfilters.com>.**

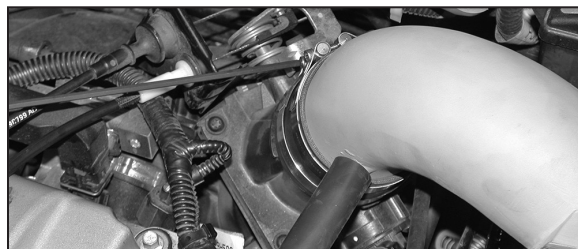

22. Adjust for best fit and clearance and tighten all hardware as shown.

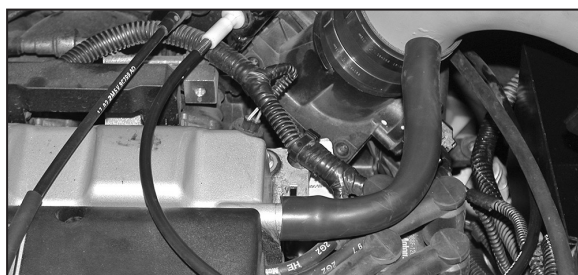

23. Reconnect the crank case vent hose to the cam cover as shown.

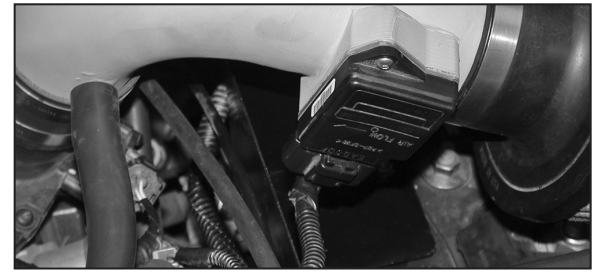

24. Reconnect the mass air sensor electrical connection as shown.

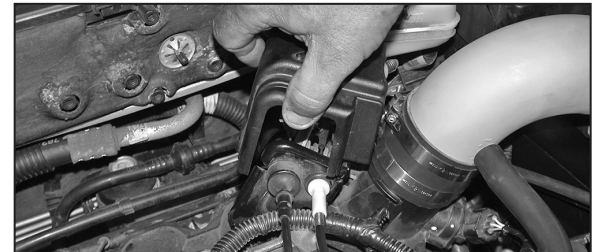

25. Reinstall the plastic throttle linkage cover as shown.



26. Reinstall the plastic coil cover as shown.

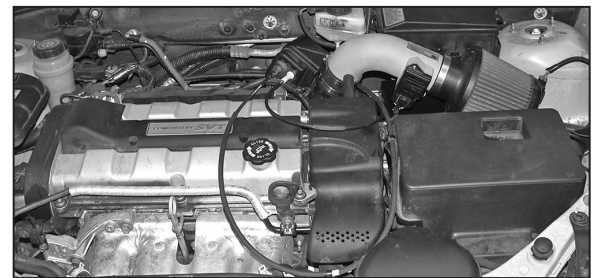

27. Reconnect the vehicle's negative battery cable. Double check to make sure everything is tight and properly positioned before starting the vehicle.

28. The C.A.R.B. exemption sticker, (attached), must be visible under the hood so that an emissions inspector can see it when the vehicle is required to be tested for emissions. California requires testing every two years, other states may vary.

29. It will be necessary for all K&N high flow intake systems to be checked periodically for realignment, clearance and tightening of all connections. Failure to follow the above instructions or proper maintenance may void warranty.

#### ROAD TESTING:

1. Start the engine with the transmission in neutral or park, and the parking brake engaged. Listen for air leaks or odd noises. For air leaks secure hoses and connections. For odd noises, find cause and repair before proceeding. This kit will function identically to the factory system except for being louder and much more responsive.

2. Test drive the vehicle. Listen for odd noises or rattles and fix as necessary.

3. If road test is fine, you can now enjoy the added power and performance from your kit.

4. K&N Engineering, Inc., requires cleaning the intake system's air filter element every 100,000 miles. When used in dusty or off-road environments, our filters will require cleaning more often. We recommend that you visually inspect your filter once every 25,000 miles to determine if the screen is still visible. When the screen is no longer visible some place on the filter element, it is time to clean it. To clean and re-oil, purchase our filter Recharger service kit, part number 99-5050 or 99-5000 and follow the easy instructions.

**INTAKE SYSTEMS FOR VEHICLES LISTED ARE 50 STATE LEGAL. SEE KNFILTERS.COM FOR CARB STATUS ON EACH PART FOR A SPECIFIC VEHICLE.**

\* FREE K&N decal To register your warranty, please see us online at [knfilters.com/register](http://knfilters.com/register). FREE K&N decal \*